

NIBCO® PEX

PIPING SYSTEMS



Installation Manual

Visit our website for the most current information.

Table Of Contents

Introduction.....	4
NIBCO® PEX Pipe Process.....	4
A Complete System.....	4
Standards and Approvals.....	4
Operating Pressure Limits.....	4
Material Selection.....	5
Pipe Markings.....	6
Crimp Tool Use.....	6
5-Step Method for a Great Crimp Connection.....	6-8
Tool Calibration.....	9
5-Step Method for a Great Clamp Connection.....	9-11
5-Step Method for a Great Sleeve Connection.....	11-13
Push 'N Go® Installation Instructions.....	13-14
Pipe Basics.....	14-16
Technical Data.....	17-18
How to Order.....	19
NIBCO® Limited Warranty.....	19

Look to NIBCO for Leadership on PEX Piping Systems

NIBCO® is proud to offer NIBCO® PEX, our potable water PEX piping system and radiant heat PEX piping system. With over 100 years of experience you can trust NIBCO to provide the highest quality PEX product.

NIBCO® PEX Pipe is produced through the PEX-c method that uses an electron beam to change the molecular structure of polyethylene, giving it enhanced physical properties over conventional polyethylene. Available in sizes from 3/8" to 1-1/4" copper tube size, NIBCO sets a new standard in PEX plumbing products.

NIBCO® PEX Pipe Offers Significant Advantages:

- NIBCO® PEX contains UV stabilizers that protect it against damage from short-term exposure to sunlight.
- NIBCO® PEX is pliable – it can be easily straightened after removal from the coil.
- NIBCO® PEX has greater dimensional stability. We hold the outside pipe diameter dimensions of our pipe to strict tolerances. This means a better fit for you with no sliding of copper crimp rings on the pipe.
- NIBCO® PEX is chlorine-resistant. It is a viable solution for aggressive water conditions.
- NIBCO® PEX is non-toxic. It employs no toxic chemicals in its manufacture, unlike other PEX manufacturing methods.
- NIBCO® PEX will not leach taste or odor. It keeps water clear and clean with no odor due to leaching from the pipe.
- NIBCO® PEX's opaque color limits light from supporting bacteria and algae growth.
- NIBCO® PEX pipe is quiet. It insulates against water hammer and noise in the pipe.
- NIBCO® PEX's natural insulation properties keep hot-water hot and cold-water cold.
- NIBCO® PEX requires fewer fittings in a typical installation and is easier to install.
- NIBCO® PEX expands if water freezes in the pipe.
- NIBCO® PEX is more resistant to abrasion than steel or copper.
- NIBCO® PEX offers you three different connection methods - crimp, clamp and sleeve.

Introduction

This handbook is intended to train and educate the professional contractor on the recommended techniques of installing NIBCO piping systems. To insure that your installation is successful, please read this manual completely. If you are unsure about any of the instructions in this manual, please contact NIBCO at 888.446.4226. NIBCO is not responsible for any misinterpretations or deviations from this manual. We recommend that you also contact your local plumbing officials to determine code acceptance of PEX systems in your area.

The NIBCO® PEX Manufacturing Process

Cross-linking is the process that gives NIBCO® PEX tubing its superior characteristics. The long, simple chains in a polyethylene molecule are altered to form a more stable, three-dimensional network. This process changes the material from a thermoplastic into a thermoset. A thermoset differs from a thermoplastic because a thermoset cannot be melted and then reformed. This change in molecular structure creates a polyethylene product with enhanced mechanical properties. Many manufacturers use a chemical additive to activate the cross-linking process, but NIBCO employs a sterile, electron beam process that provides superior properties. This process, which is called PEX-c, delivers the highest quality PEX tubing available today, while reducing the use of chemicals.

NIBCO® PEX is a Complete System

NIBCO® PEX tubing, fittings, valves, and manifolds are designed to be used as a complete system. Therefore, NIBCO cannot guarantee that tubing and/or components from other systems are compatible for use with the NIBCO® PEX system. NIBCO offers more versatility with the choice of three different connections - crimp, clamp or sleeve.

Standards and Approvals

NIBCO® PEX is an outside diameter controlled tubing of one standard dimension ratio (SDR 9) that is manufactured to comply with the requirements of CSA B137.5, ASTM F 876, and ASTM F 2023. NIBCO® PEX insert fittings and copper crimp rings are manufactured to comply with CSA B137.5 and ASTM F 1807. NIBCO® PEX tubing, fittings, and crimp rings are tested as a system to the requirements of ASTM F 877. NIBCO® PEX tubing components are listed for compliance to NSF/ANSI 14 and NSF/ANSI 61 by NSF International for use in potable water systems. NIBCO® PEX tubing has also been tested and certified by the International Association of Plumbing and Mechanical Officials (IAPMO).



Operating Pressure Limits

Water: 160 PSI @ 73° F (1.10 MPa @ 23° C)
100 PSI @ 180° F (0.69 MPa @ 82° C)

Chlorinated Water: 80 PSI @ 140° F (0.55 MPa @ 60° C)

The water temperature must be 140° F (60° C) or lower and the water pressure must be 80 PSI (0.55 MPa) or lower*

*Systems with back flow protection are "closed systems" and are subject to thermal expansion when water is heated. Protection against increased water pressure from thermal expansion utilizing a pressure relief valve or expansion tank to keep system pressure under the maximum of 80 PSI (0.55 MPa) must be incorporated in the system.

Material Selection

Plastic Piping Standards

Many commercial, industrial, and governmental standards or specifications are available to assist the design engineer in specifying plastic piping systems. Standards most frequently specified in plastic piping systems are American Society for Testing and Materials (ASTM) Standards. Below is a list and description of those standards most typically applied to industrial plastic piping.

Polyethylene (PE)

Polyethylene is the most common olefin material and is typically used in transporting water. Because olefins cannot be joined with cements, barbed insert fittings are used for mechanical assembly. PE is light weight, low cost, has excellent chemical resistance, low coefficient of friction, and is non-toxic.

Cross-Linked Polyethylene (PEX)

PEX is the common name for cross-linked polyethylene. PEX tubing is predominantly used in water distribution systems, hydronic radiant heating systems, and natural gas systems.

Almost all PEX is made from high density polyethylene (HDPE). PEX contains cross-linked bonds that are introduced into the polymer structure, changing the thermoplastic into a thermoset. Cross-linking is accomplished during or after the extrusion of the tubing. The required degree of cross-linking, according to ASTM F 876, is between 65 to 89 percent.

The cross-linking process improves high-temperature mechanical properties, low-temperature impact, tensile strength, resistance to brittle fracture, and scratch resistance properties.

Cross-linking may be done by the peroxide (Engel) method, silane (moisture cure) method, or electron beam method. NIBCO® PEX is produced by the electron beam method. This is the cleanest and most environmentally friendly of the three methods. Also this method does not involve other chemicals and uses only high-energy electrons to split the carbon-hydrogen bonds and facilitate cross-linking.

Polyphenylsulfone (PPSU)

Polyphenylsulfone is a thermoplastic that is tough, rigid, high-strength, and retains its properties between -148° F and 302° F (-100° C and 150° C). PPSU has very high dimensional stability; the size change when exposed to boiling water or 302° F (150° C) air generally falls below 0.1 percent. Polyphenylsulfone is highly resistant to mineral acids, alkali, and electrolytes, in pH ranging from 2 to 13. PPSU is resistant to oxidizing agents; therefore, can be cleaned by bleaches. Also, PPSU is resistant to surfactants and hydrocarbon oils. However, PPSU is not resistant to low-polar organic solvents (e.g., ketones and chlorinated hydrocarbons) and aromatic hydrocarbons. In addition, PPSU is often chosen for difficult applications including high water temperatures, chlorides, or when water quality may increase the risk of dezincification, a type of corrosion that can adversely affect metal fittings.

Brass

Brass is the term used for copper alloys where zinc is the principle alloying element along with copper. Brass has a yellow color, somewhat similar to gold. Brass plumbing components may be machined from extruded shapes, forged, or cast. This alloy is mainly used for decorative fixtures, plumbing components, and electrical applications. Today, almost 90% of all brass alloys are recycled.

Copper (Cu)

Copper (Cu) is a natural element that has historically been the dominant material used in plumbing, heating, cooling, and other piping applications. Copper is a ductile metal with excellent thermal conductivity and is corrosion resistant. The materials used in copper piping products comply with the requirements of specifications established by the American Society for Testing and Materials (ASTM). The alloy customarily used for copper tube and copper fittings is designated as C12200 (Copper No. 122). This alloy contains a minimum of 99.9% pure copper and is deoxidized by the addition of phosphorus. Other copper alloys may be used.

Tube Markings

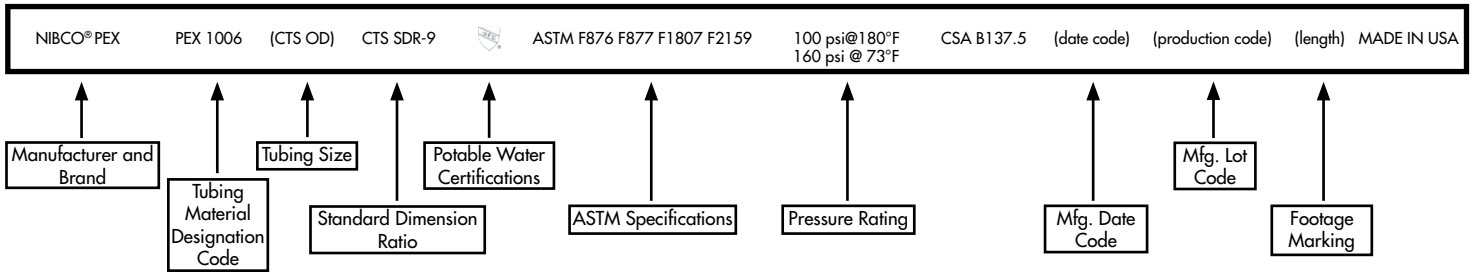

Crimp Tool Use

The crimp tools supplied with the NIBCO® PEX system are high quality instruments designed for heavy-duty use. However, normal use will require that these tools be adjusted on occasion. Before beginning a job, the installer should conduct a “test” crimp to ensure that the tool is working properly. If several consecutive joints fail the go /no-go gauge, then the tool may be out of adjustment. During normal wear conditions, the crimp tool’s crimp diameter tends to increase. NIBCO tools come with instructions for maintaining the tool and keeping it in proper adjustment. Please follow these instructions.

NIBCO’s 5-Step Method for a Great Crimp Connection

Because NIBCO® PEX pipe is extruded to tight tolerances you don’t have to worry about crimp rings sliding or insert fittings falling out as the system is being “roughed in.” The installer can quickly “hand fit” the system, then go back and crimp each fitting to make the connection permanent. After crimping, our connections form a reliable and permanent seal. After all connections have been crimped, the system can be immediately pressure tested. There is no need to wait for the pipe to return to a set position. NIBCO crimped connections are immediately permanent whether the installation temperature is hot or cold.

We urge you to thoroughly read the instructions for our 5-step method before beginning any installation.

Step 1

Cut the pipe to length squarely. A rough, jagged or irregular cut may result in a failed connection.

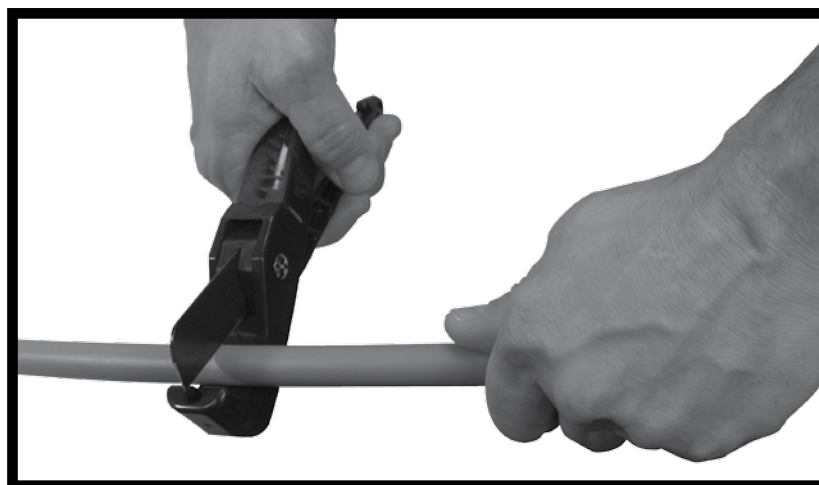

Step 2

Slide the correct sized copper crimp ring over the end of the NIBCO® PEX pipe. Slide the ring approximately 2" past the end of the pipe.



Step 3

Push the fitting into the pipe until it touches the fitting shoulder. Position the crimp ring 1/8" - 1/4" from the end of the tube. This distance ensures that the crimp ring is positioned directly over the ribs on the barb.

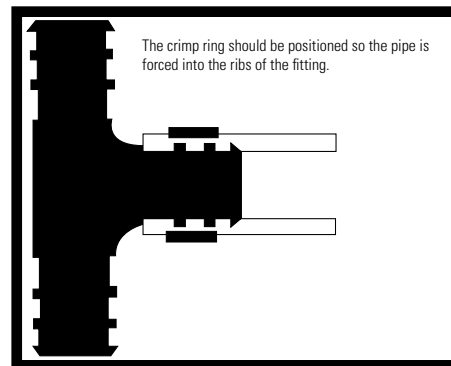
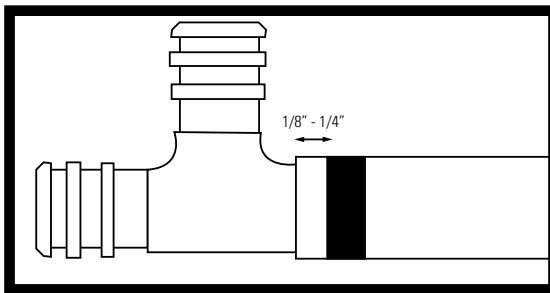
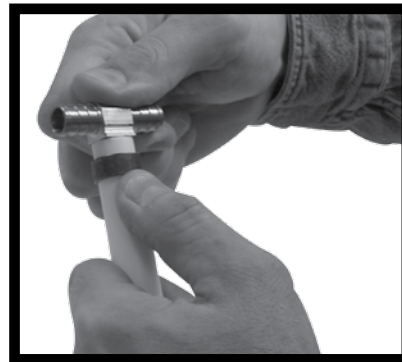

Step 4

Center the crimping tool jaws over the ring. Hold the tool at 90 degrees to the fitting and close the jaws completely. Crimp only one time. If crimped more than once, you must cut out the connection and begin again at Step 1.

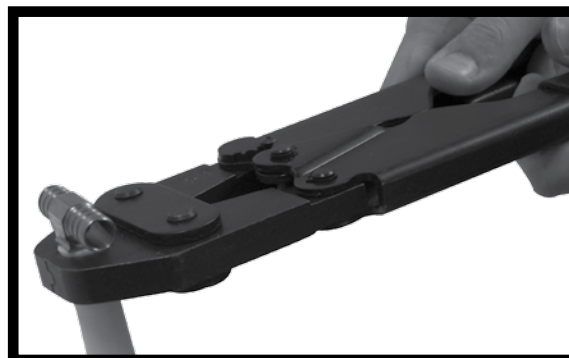

Step 5

Use the go/no-go gauge to check every crimp joint. Push the gauge at a 90 degree angle over the crimp ring. If the crimp ring fits through the "go" slot and can rotate around the circumference of the crimp ring, then the joint was made correctly. Mark fitting as good and proceed. If the joint doesn't fit through the "go" slot then the joint was not formed correctly. An improper crimp has been formed when (1) the "go" side does not fit over the ring or, (2) the "no" side does fit over the ring. If the joint fails either of these two tests then cut out the joint and return to Step 1.

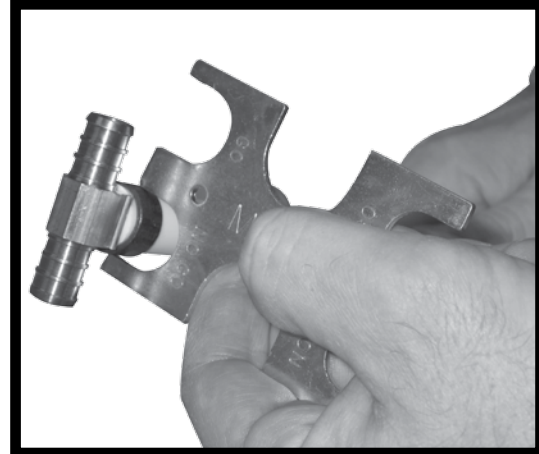

CRIMP GAUGE

No-go

No-go

No-go

Go

Go

Go

A micrometer can be used to measure the correct dimensions of a crimp ring after a proper, single crimp per the following table:

Tube Size	Min	Max
3/8"	0.580"	0.595"
1/2"	0.700"	0.715"
3/4"	0.945"	0.960"
1"	1.175"	1.190"
1-1/4"	1.430"	1.445"

BAD CRIMPS

Ring is compressed too much.

Ring is not compressed sufficiently.

No Go

Go

GOOD CRIMPS

Ring is properly compressed. Does not fit in "No-Go" slot.

Ring fits in "Go" slot.

No Go

Go

Tool Calibration

Normal wear and tear in the field requires the crimp tool to be adjusted. After numerous crimps, the crimp diameter will increase. To adjust for a tighter crimp:

- Remove the E-clip
- Slide the back pin head out about 1/4"
- Rotate the back pin until the line on the hex head points to the next higher number
- Push the pin back in
- Refit the E-clip

The tool can be adjusted 5 times.

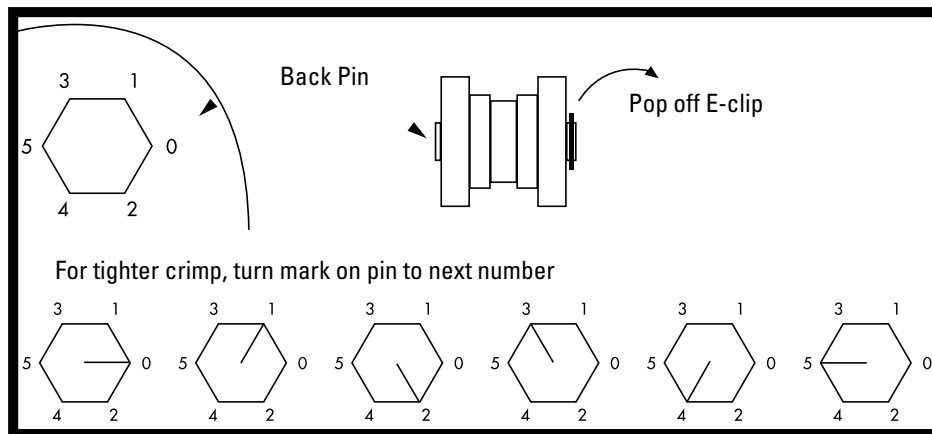

NIBCO's 5-Step Method for a Great Clamp Connection

Our NIBCO clamp connection system with its interlocking ring gives you the same high integrity connection as a crimp connection. Its advantage is that you will only need one tool for all sizes from 3/8" to 1". The clamp method is great for hard to reach areas. In addition, it is nearly impossible to make a bad joint since the ratchet action of the tool does not allow the tool to return to its original position until the tool has been completely compressed and the tabs of the clamp have been formed. Once the connection has been completed, it is easy to determine if the connection has been made by visually inspecting the formation of the tab on the clamp.

Important: Clamps are for use on brass and poly fittings only. Do not use clamps on copper insert fittings or copper stub outs.

Step 1

Cut the pipe to length squarely. A rough, jagged or irregular cut may result in a failed connection.

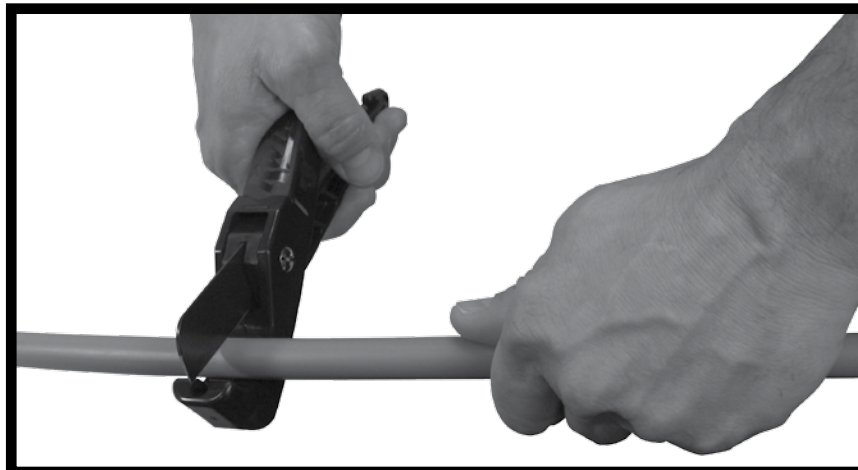

Step 2

Slide the correct sized stainless steel clamp ring over the end of the NIBCO® PEX pipe. Slide the ring approximately 2" past the end of the pipe.

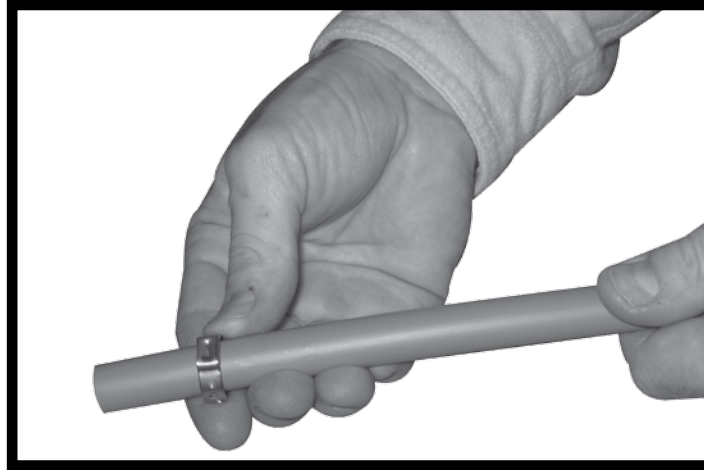

Step 3

Push the fitting into the pipe until it touches the fitting shoulder. Position the clamp ring 1/8" - 1/4" from the end of the tube. This distance ensures that the clamp ring is positioned directly over the ribs on the barb.

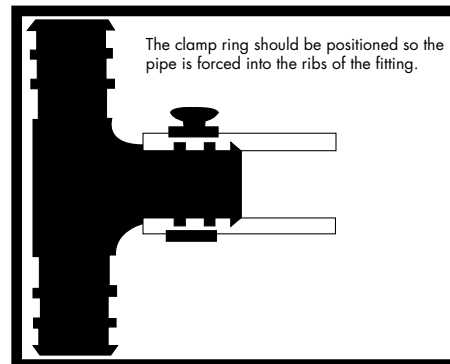
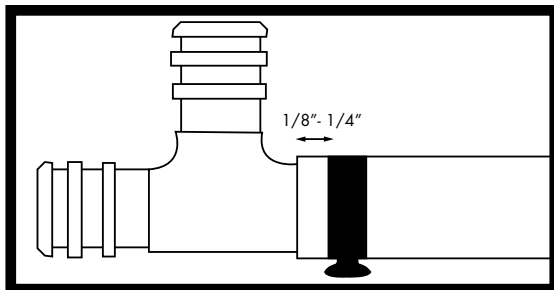
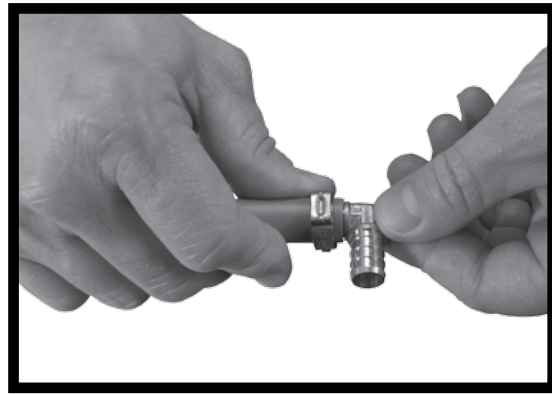
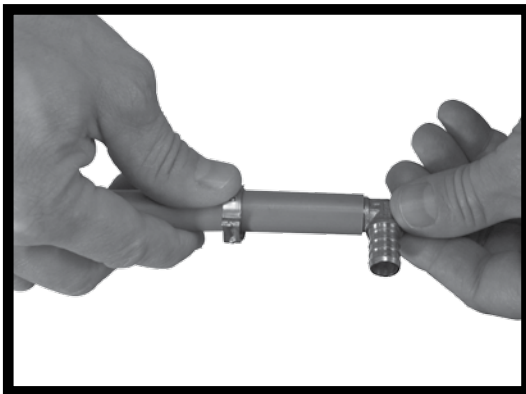

Step 4

Position the open jaws of the NIBCO clamp tool over the raised tabs of the clamp and squeeze.



Step 5

Verify the connection is secure by visually checking the clamp tab. The tab should be formed as in the picture below.



NIBCO's 5-Step Method for a Great Sleeve Connection

Our NIBCO sleeve connection system is fast, easy and leaves a great looking connection. Simply slide the sleeve over the end of the pipe, push in the fitting, and crimp the sleeve with our special sleeve tool. Because the sleeve has a positive stop, there is no need to worry about it sliding around on the pipe. The view hole on the side of the sleeve helps guarantee that the sleeve is properly inserted.

Step 1

Cut the pipe to length squarely. A rough, jagged or irregular cut may result in a failed connection.

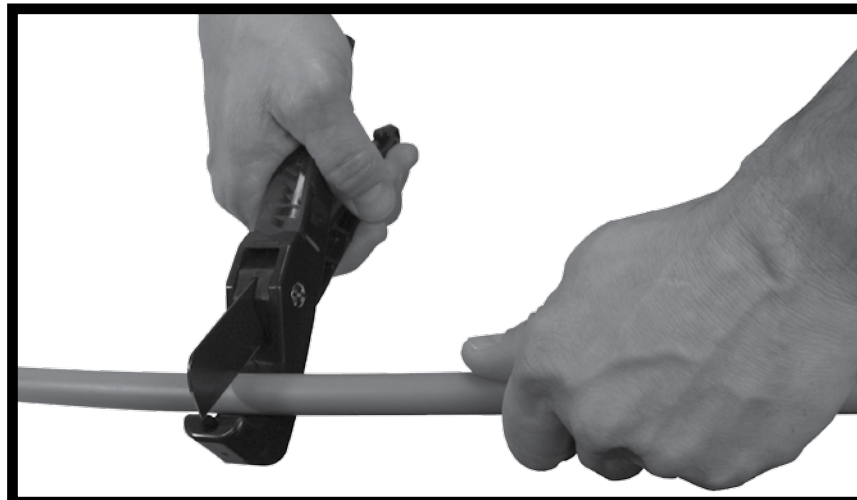

Step 2

Slide the correct sized stainless steel sleeve over the end of the NIBCO® PEX pipe until it bottoms out. Look at the view hole on the side to see if it is over the pipe.

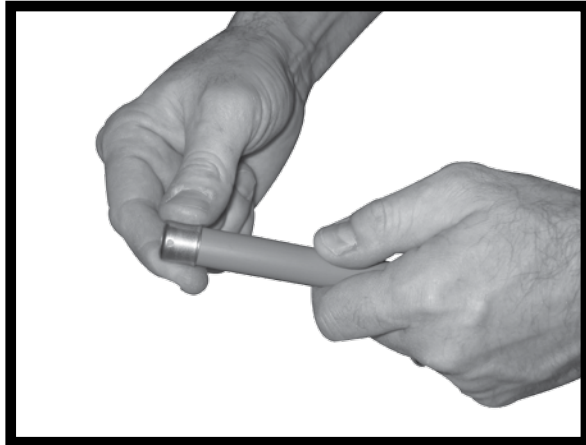
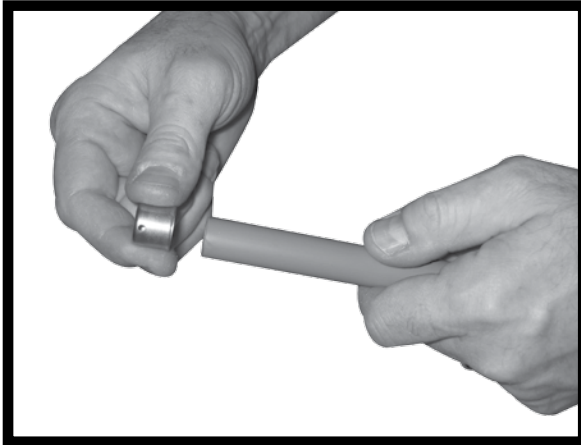

Step 3

Push the fitting into the pipe until it touches the fitting shoulder.



Step 4

Center the sleeve tool jaws over the ring. Hold the tool at 90 degrees to the sleeve and close the jaws completely. Crimp only one time. If crimped more than once, you must cut out the connection and begin again at Step 1.

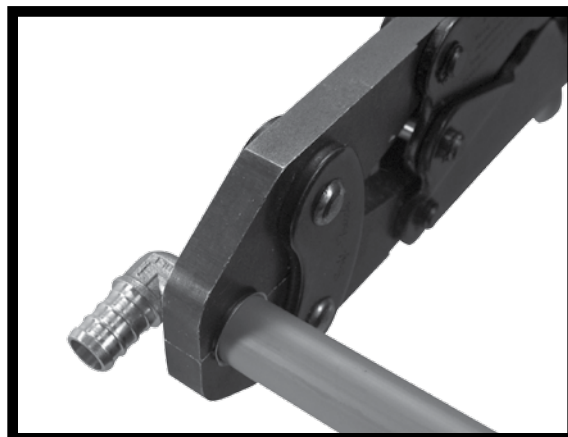

Step 5

Visually inspect the completed connection. If the pipe can be seen from the view hole on the side of the sleeve and a “W” shaped crimp has been formed around the sleeve, then a good connection has been made.

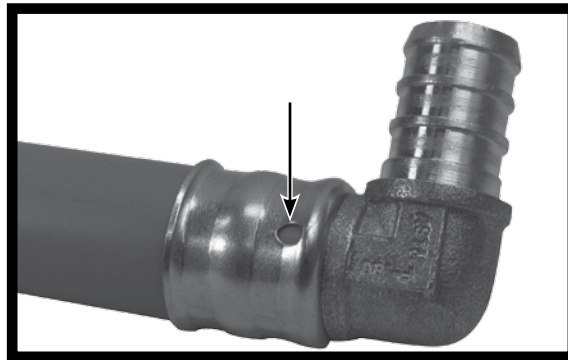
**PUSH 'N GO® Installation Instructions**

Our NIBCO Push 'N Go fittings are designed for a quick and hassle-free installation. No tools, crimp or solder is required. These polyphenylsulfone fittings are sturdy enough to handle projects for plumbing systems, radiant heat systems and quick fixes. It is recommended that Push 'N Go fittings be used only with plastic CTS tubing. Disassembly is easy as well. Simply push in the gripper ring and pull out the pipe. No special tool is required.

Step 1

Get your pipe and fitting ready to connect.

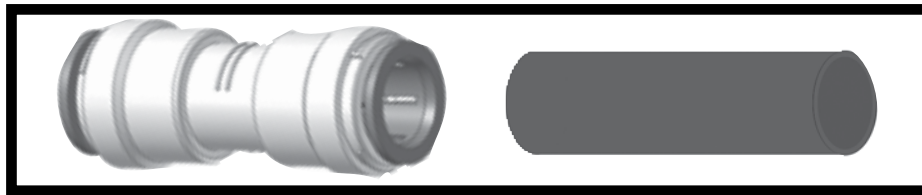
**Step 2**

Push pipe into the fitting until it stops and you're done.

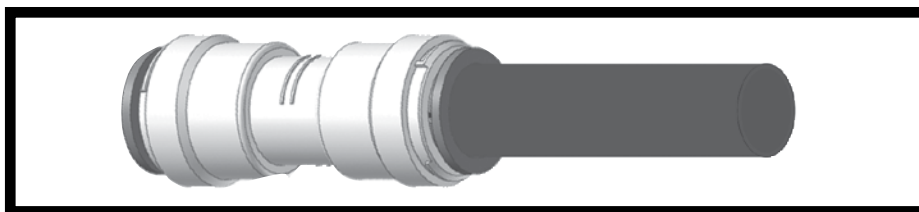
**Features and Benefits**

- Quick-connect fittings that can be used in both potable water and radiant heating systems.
- Made of polyphenylsulfone which has been proven in extensive tests for cleanliness, pressure, flow, longevity, chemical exposure and chlorine resistance.
- Works with plastic CTS tubing.
- No tools, crimp or solder required. Simply push pipe into fitting.
- Easy to disassemble - Push in gripper ring and pull out pipe.
- Available from 1/2" through 3/4"
- Locking clips available for behind the wall installation.

Performance Standards

ASTM F 877 Cross-linked polyethylene plastic hot- and cold-water distribution systems
 NSF-PW Combination of performance and health effects standards for fittings to be used with potable water

NIBCO® PEX Pipe Basics

Recognize Minimum Bending Radius Guidelines

Because NIBCO® PEX pipe is flexible, it can be installed easier than rigid systems. It can be bent to make turns or navigated around obstructions, thus lowering the number of fittings required in the installation. The minimum bend radius for NIBCO® PEX pipe is eight times the outside diameter of the pipe. NIBCO bend supports can be used to hold a turn in place. Hangers that do not pierce or damage the pipe wall may also be used to support the system.

BENDING RADIUS

Tubing Size	Min. Radius
1/4"	4"
3/8"	5"
1/2"	6"
5/8"	6"
3/4"	9"
1"	11"
1-1/4"	14"

Always Properly Support NIBCO® PEX Pipe

Our cross-linked NIBCO® PEX pipe is tough and durable. Yet, in most applications, it must be properly supported to protect against excessive strain. Please observe the following guidelines. Codes require the use of approved fastening devices. Make sure that supports designed for use with plastic pipe are used whether one is mounting to either wood or steel. Metal supports designed for use with plastic pipe may be used. Never use supports that have sharp edges. For both vertical and horizontal runs, we recommend the pipe be supported every 32" between each support, leaving a little slack ($1/8"$ to $3/16"$) in the tube to allow for normal expansion / contraction. Never pull the tubing tight during the installation.

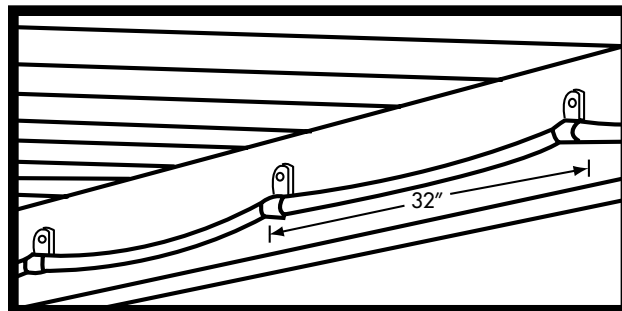

Allow for Expansion and Contraction

Since NIBCO® PEX pipe will expand and contract during temperature changes, please allow slack when stringing the pipe through the building. NIBCO® PEX pipe expands/contracts at a rate of 1.1" per 100 feet of pipe for each 10°F change in temperature. For example, a line at 70°F room temperature will expand 5.5" over a 100' length when 120°F water is run through it. ($120^{\circ} - 70^{\circ} = 50^{\circ}$; $50^{\circ}/10^{\circ} = 5^{\circ}$; $5 \times 1.1" = 5.5"$) Conversely, the pipe will shrink 5.5" when it cools down. We recommend that offsets and expansion loops be used as ways to compensate for expansion and contraction in runs of pipe.

Examples of Expansion/Contraction Loop Methods



Make sure that the loops have adequate room to expand and contract. Ensure that the loop is not touching any floor joists or wall studs.

Remember to Leave Extra Tubing at Both Ends of the Run

Connections to fittings, fixtures and manifolds are made easier by leaving some extra tubing at both ends of the run.

Keep Hot and Cold Lines Separate

NIBCO® PEX pipe keeps hot-water hot and cold-water cold due to its superior insulation properties. However, please use caution when bundling pipe. Keep hot and cold lines in separate bundles to avoid heat transfer problems.

Use Caution When Soldering

When installing a sweat adapter fitting, always solder the fitting first before making the connection to NIBCO® PEX pipe. In all cases, keep soldering tools and open flames away from NIBCO® PEX pipe.

Concrete Installation Guidelines

NIBCO® PEX can be submerged in concrete but please follow these guidelines.

- Protect the pipe with non-metallic sleeves when entering or exiting the concrete slab. A larger diameter piece of NIBCO® PEX works well in this application.
- Do not allow any joints within the slab. Use a continuous length of NIBCO® PEX pipe within the slab and be sure to check for leaks before pouring any concrete.

Keep NIBCO® PEX Away from High Heat Sources

NIBCO® PEX pipe should be routed around and away from sources for heat such as water heaters / boilers, electric motors, light fixtures and gas appliance vents. Maintain a minimum distance of 12" vertically and 6" horizontally from sources of high heat.

NIBCO® PEX Fixture Connections

- A metal adapter at least 12" long should be used to connect NIBCO® PEX pipe to a gas water heater.
- NIBCO® PEX pipe can be connected directly to an electric water heater using metal insert adapters.
- NIBCO® PEX pipe can be connected to PEX insert accessories as long as the barb meets ASTM F 1807 specifications. Such accessories include supply stop valves, ball valves, icemaker boxes, washing machine boxes, copper stub outs and manifolds, etc.

Recirculating Loops

NIBCO® PEX pipe with NIBCO® PEX insert fittings can be used for recirculation lines as long as the operating limits of the pipe pressure and temperature are not exceeded (max. 80 PSI, max. 140° F for chlorinated water.)

Fire Proof Caulking

When sealing a penetration for air infiltration purposes, silicone or acrylic caulks, canned expanding foams and open or closed cell pipe insulation may be put in direct contact with NIBCO® PEX. Do not use any oil based caulks. If there is no information about the compatibility of a sealing material with NIBCO® PEX, wrap the tubing in several layers of aluminum foil which extends several inches beyond the area of contact before applying the sealant.

Pressure Testing and Inspection of the Completed System

After complete installation, the system should be tested. Local code requirements should be consulted for proper testing.

- Test system with water.
- Test pressure shall be at least equal to the expected working pressure (main pressure), but not less than 40 psi and not greater than 225 psi at 73°F.
- Compressed air testing is only recommended when water is not available or when cold weather could freeze the system. Compressed air tests shall include appropriate safety precautions and the test pressure shall not exceed 100 psi. PEX tubing is ductile and will not shatter during a pressure test and release shards of plastic. However, plastic fittings or other system components, or unassembled fittings, may cause a hazard. Check with local codes before using air pressure testing.
- Test duration should not be less than 15 minutes.
- Do not allow water in systems to freeze.

Freeze Resistance

PEX piping is freeze damage resistant and can expand and contract as water freezes and thaws within the tubing. No tubing material is freeze-break proof, however, and PEX should be installed using the same locally-prescribed insulation requirements to prevent freezing of any plumbing system.

Technical Data

PRESSURE DROP AT AMBIENT TEMPERATURE (PSI / FT)

GPM	3/8"	1/2"	5/8"	3/4"	1"	1 1/4"		
1	0.071	0.016	0.006	Water Velocity too low				
2	0.254	0.058	0.021					
3	0.538	0.122	0.045					
4		0.207	0.076					
5		0.313	0.115	0.054	Water Velocity too high			
6		0.439	0.161	0.076				
7		0.584	0.214	0.101				
8			0.224	0.130				
9			0.340	0.161			0.051	
10				0.196			0.062	0.023
12.5				0.274			0.094	0.035
15				0.414			0.132	0.049
20							0.224	0.084
25							0.339	0.127
30						0.178		
40						0.304		
50						0.459		

NOTE: Pressure Drop x 2.307 = Feet of Head

NIBCO® PEX PIPE DIMENSIONS

Nominal ID	OD	Wall Thickness	Average ID
1/4"	0.275	0.062	0.225
3/8"	0.500	0.070	0.350
1/2"	0.625	0.070	0.475
5/8"	0.750	0.083	0.574
3/4"	0.875	0.097	0.681
1"	1.125	0.125	0.862
1-1/4"	1.275	0.153	1.054

FLUID CAPACITY OF NIBCO® PEX PIPE

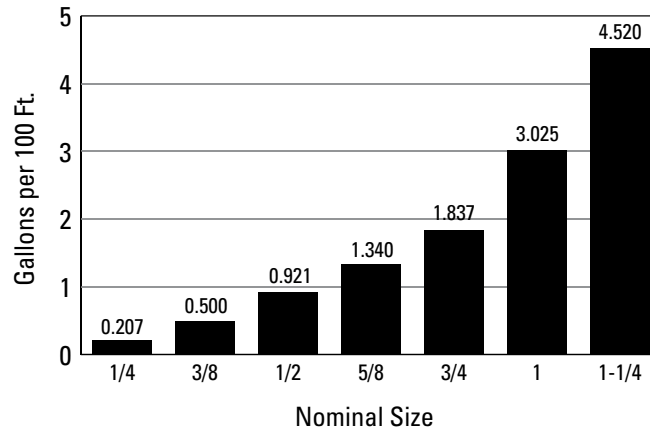

BUNDLE QUANTITY

Tubing Size	20' Lengths
3/8"	50
1/2"	50
5/8"	N/A
3/4"	25
1"	15
1-1/4"	10

COILS / PALLET

Tubing Size	100'	250'	300'	500'	1000'
1/4"	40	30	N/A	15	N/A
3/8"	28	15	N/A	10	8
1/2"	20	10	N/A	8	6
5/8"	20	8	10	7	3
3/4"	13	9	N/A	7	4
1"	20	5	6	3	N/A
1-1/4"	8	4	N/A	N/A	N/A

WEIGHT PER UNIT

Tubing Size	20'	100'	250'	300'	500'	1000'
1/4"	0.60	3.00	7.50	9.00	15.00	30.00
3/8"	0.90	4.50	11.25	13.50	22.50	45.00
1/2"	1.15	5.75	14.38	17.25	28.75	57.50
5/8"	1.60	8.00	20.00	24.00	40.00	80.00
3/4"	2.10	10.50	26.25	31.50	52.50	105.00
1"	3.50	17.50	43.75	52.50	87.50	175.00
1-1/4"	5.50	27.50	68.75	82.50	137.50	275.00

How to Order

NIBCO sells its products through select stocking distributors. Our distributors are knowledgeable about plastic plumbing systems and the NIBCO® PEX line. Please go to www.nibco.com for a complete listing of distributors in your area.

NIBCO INC.
World Headquarters
1516 Middlebury Street
Elkhart, IN 46516-4740
USA

NIBCO Customer Service
Phone: 800.234.0227
Fax: 800.234.0557

NIBCO Technical Service
Phone: 888.446.4226
Fax: 888.336.4226

NIBCO Limited Warranty

NIBCO INC. warrants that when NIBCO® PEX pipe is used with NIBCO® PEX fittings, and NIBCO valves and installation accessories, they will, under normal conditions, use and service in potable water and radiant heat systems, be free from defects in materials and workmanship for a period of twenty-five (25) years from the date of purchase when installed by a licensed professional contractor. This 25 year warranty is voided if any non-NIBCO products are used in the PEX system. NIBCO INC. warrants NIBCO® PEX pipe, when used under normal conditions, use and service in potable water and radiant heat systems with brass insert fittings meeting NSF/ANSI 61, ASTM F 1807 and ASTM F 877 to be free from defects in materials and workmanship for a period of ten (10) years from the date of purchase. NIBCO INC. warrants NIBCO® PEX fittings, manifolds, transition fittings and valves under normal conditions, use and service in potable water and radiant heat systems, to be free from defects in materials and workmanship for a period of ten (10) years from the date of purchase. NIBCO INC. warrants NIBCO associated hardware and tools for a period of 90 days from the date of purchase. In the event any defect occurs which the owner believes is covered by this Warranty, the owner should immediately contact NIBCO INC., Technical Services, either in writing or by telephone call, (888) 446-4226 or (574) 295-3000. The owner will be instructed to return said pipe, fittings or accessories, at the owner's expense, to NIBCO INC. or an authorized NIBCO INC. representative for inspection. In the event said inspection discloses to NIBCO INC.'s satisfaction that said pipe, fitting or accessory is defective, a replacement shall be mailed free of charge to the owner. **IN ORDER FOR THIS LIMITED WARRANTY TO APPLY, THE ABOVE REFERENCED PRODUCTS MUST BE INSTALLED BY A LICENSED PROFESSIONAL PLUMBER IN ACCORDANCE WITH NIBCO INSTALLATION INSTRUCTIONS AND IN COMPLIANCE WITH ALL APPLICABLE CODE REQUIREMENTS. FAILURE TO DO SO WILL VOID ALL APPLICABLE WARRANTIES.** This warranty does not apply and you do not have a right of reimbursement if the failure or resulting damage is caused by:

- 1) breaks, tearing, kinking, gouges, punctures or other external damages before, during, or after installation;
- 2) exposure to temperatures and pressures beyond the product ratings as specified on the product or in the NIBCO installation manual;
- 3) exposure to damaging chemicals, substances or corrosive water conditions;
- 4) damage from abnormal operating conditions;
- 5) damage due to accident, abuse, misuse, or unauthorized modification or repair;
- 6) improper installation due to worn, damaged, unauthorized or improperly calibrated tools;
- 7) components in the plumbing system other than those manufactured or sold by NIBCO;
- 8) not designing, installing, inspecting or testing the system in accordance with NIBCO installation instructions at the time of the installation; or
- 9) failure to follow applicable code requirements and good plumbing practices.

TO THE EXTENT PERMITTED BY LAW, THIS WARRANTY SPECIFICALLY EXCLUDES INCIDENTAL AND CONSEQUENTIAL DAMAGES OF EVERY TYPE AND DESCRIPTION RESULTING FROM ANY CLAIMED DEFECT IN MATERIAL OR WORKMANSHIP, INCLUDING BUT NOT LIMITED TO, PERSONAL INJURIES AND PROPERTY DAMAGES. Some states do not allow the exclusion or limitations of incidental or consequential damages, so these limitations may not apply to you. **TO THE EXTENT PERMITTED BY LAW, IMPLIED WARRANTIES OF MERCHANTABILITY AND FITNESS FOR A PARTICULAR PURPOSE ARE LIMITED IN DURATION.** This Warranty gives you specific legal rights, and you may also have other rights which vary from state to state.

FEATURING NIBCO® SYSTEMS

NIBCO® PEX Piping Systems • NIBCO® Press System®

FITTINGS



Wrot and cast copper pressure and drainage fittings • Cast copper alloy flanges
• Wrot and cast press fittings • ABS and PVC DWV fittings • Schedule 40 PVC pressure fittings • CPVC CTS fittings • CPVC CTS-to-metal transition fittings
• Schedule 80 PVC and CPVC systems • CPVC metric piping systems
• CPVC BlazeMaster® fire protection fittings • Lead-Free* fittings

BlazeMaster® is a registered trademark of The Lubrizol Corporation.
*Weighted average lead content ≤0.25%

VALVES & ACTUATION

Pressure-rated bronze, iron and alloy-iron gate, globe and check valves • Pressure-rated bronze ball valves • Boiler specialty valves • Commercial and industrial butterfly valves • Circuit balancing valves • Carbon and stainless steel ball valves
• ANSI flanged steel ball valves • Pneumatic and electric actuators and controls
• Grooved ball and butterfly valves • High performance butterfly valves • UL/FM fire protection valves • MSS specification valves • Bronze specialty valves • Low pressure gate, globe, check and ball valves • Frostproof sillcocks • Quarter-turn supply stops • Quarter-turn low pressure valves • PVC ball valves • CPVC CTS ball valves • Just Right® recirculating valves • Bronze & Iron Y-Strainers
• Lead-Free* valves

*Weighted average lead content ≤0.25%



CHEMTROL®



Thermoplastic pipe, valves and fittings in PVC, Corzan® CPVC, polypropylene and PVDF Kynar® • Pneumatic and electric actuation systems

Corzan® is a registered trademark of The Lubrizol Corporation. • Kynar® is a registered trademark of Arkema Inc.

TOLCO®

Pipe hangers • Custom fabricated supports • Strut fittings • Seismic bracing • TOLBrace® Fire seismic bracing software • Markets served include commercial, industrial & fire protection

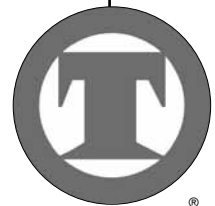

eNIBCO



EDI—Electronic Data Interchange • VMI—Vendor Managed Inventory
• NIBCO.com • NIBCOpartner.com

NIBCO®

AHEAD OF THE FLOW®

NIBCO INC.
WORLD HEADQUARTERS
WEB: www.nibco.com

1516 MIDDLEBURY STREET
ELKHART, IN 46516-4740
USA

DOMESTIC CUSTOMER SERVICE
PHONE: 800.234.0227
FAX: 800.234.0557

TECHNICAL SERVICE
PHONE: 888.446.4226
FAX: 888.336.4226

INTERNATIONAL OFFICE
PHONE: +1/574.295.3327
FAX: +1/574.295.3455